

Paul Harden, NA5N

The Handyman's Guide to – UNDERSTANDING TRANSISTOR DATA SHEETS & SPECIFICATIONS

Introduction

The most common bipolar junction transistors (BJT) used by hobbyists and QRPers are the 2N2222, 2N3904 and 2N4401. These NPN transistors have similar characteristics, and perform well at HF frequencies.

This tutorial explains how to "read" the data sheets on these devices and understand the specifications – which will enable you to interpret data sheets for other devices as well.

The manufacturer's data sheets contains information in the following general categories:

1. Maximum (Breakdown) Ratings
2. "On" Characteristics
3. Small Signal Characteristics
4. Switching Characteristics

1. Maximum (Breakdown) Ratings

The maximum ratings are provided to ensure that the voltages and currents applied do not damage or cause excessive heating to the device. The maximum ratings for the 2N2222, 2N3904 and 2N4401 are shown in **Table 1**. The voltages, currents and power dissipation listed should *not be exceeded* to prevent damage to the device.

V_{CEO} is the maximum **collector-emitter voltage** and **V_{CB0}** is the maximum **collector-base voltage**. Fortunately, these breakdown voltages are well above the typical 12v used in most QRP applications.

This is not the case with **V_{EB0}**, the **maximum emitter-base voltage**, typically 5–6v. If exceeded, this can cause a physical breakdown of the base junction, destroying the

The QRPer's Favorite

GENERAL PURPOSE
NPN TRANSISTORS

2N2222
2N3904
2N4401
MPS2222
MPS3904

TO-92

Plastic Encapsulated
Transistor

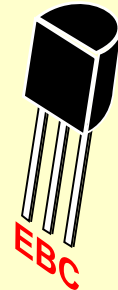

TO-18

Metal Can
Transistor

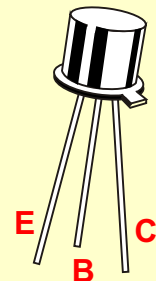
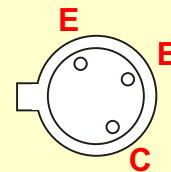

SOT-23

Surface Mount
Transistor

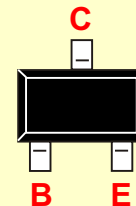

MMBT2222LT1
MMBT3904LT1
MMBT4401LT1

Table 1 – MAXIMUM (BREAKDOWN) RATINGS

		2N 2222	2N 2222A	2N 3904	2N 4401	MMBT 3904
Collector–Emitter	V _{CEO}	30v	40v	40v	40v	40v
Collector–Base	V _{CB0}	60v	75v	60v	60v	60v
Emitter–Base	V _{EB0}	5v	6v	6v	6v	6v
Max. Coll. Current	I _c	600mA	600mA	200mA	600mA	200mA
Power dissipation	P _d	625mW	625mW	625mW	625mW	225mW

transistor. In a circuit, the biasing scheme sets the base-emitter voltage, V_{BE} , to be safely below V_{EBO} . However, in large-signal applications, V_{BE} must include the DC base bias and the peak voltage of the signal to ensure V_{EBO} will not be exceeded.

Collector Current, $I_c(\max)$, is the other maximum rating to be closely followed. Collector current exceeding $I_c(\max)$ can damage the transistor, due to excessive current through the device, initiating thermal runaway – destroying the collector-emitter junction. The destruction of a transistor in this manner is technically called *catastrophic substrate failure* for good reason!

Most QRP circuits are usually biased for well below $I_c(\max)$. $V_{be}(\max)$ and $I_c(\max)$ are generally a concern only in large-signal applications, such as RF drivers, PA stages, and some oscillator circuits.

2. ON CHARACTERISTICS

These specifications define the DC performance of the device while it is forward biased ($V_{be} \geq 0.7v$), causing collector current to flow, or "on." The DC Characteristics in **Table 2** are not absolute design values, but rather *test values* as measured by the manufacturer. This is why the data is listed with the test conditions, such as " $I_c=1mA, V_{CE}=10v$."

HFE is the *measured DC current gain* of the transistor (see *Rule of thumb for HFE*). It is used for biasing the device in the linear region – primarily class A. Most data sheets provide HFE at two different collector currents, usually 1 and 10mA. Since most QRP circuits are biased for $I_c \leq 5mA$ (to conserve battery drain), HFE at $I_c=1mA$ is typically used.

HFE also varies from transistor-to-transistor. This is why the data sheets list both HFE (min) and HFE (max). The manufacturer tested a large batch of 2N2222s and determined that hfe ranged from 50 (HFE **min**) to 150 (HFE **max**) at $I_c=1mA$, as shown on the data sheets (**Table 2**). Statistically, most transistors will fall between 50 and 150, or about $HFE=100$. This is why most design guides will recommend using a value of $HFE=100$ for bias calculations. Since the 2N3904 has a higher DC current gain, often $HFE=150$ is recommended for that device.

HFE min. and max, at $I_c=1$ and 10mA, can be plotted on a logarithmic graph (lines 1 and 2 on **Fig. 1**). The average

Rule of thumb for V_{EBO} : $V_{EBO}(\max)$ or $V_{be}(\max)$ for most general purpose BJTs is 5–6v – the *maximum* emitter-base voltage. Don't forget to include the peak voltage of the AC signal!

Rule of thumb for $I_c(\max)$: There isn't one! The only safe way to know the maximum I_c for a transistor is to consult the data sheets.

Table 2 – DC "ON" CHARACTERISTICS

		2N 2222	2N 2222A	2N 3904	2N 4401	MMBT 3904
DC Current Gain, HFE						
$I_c= 0.1mA, V_{CE}=10v$	HFE Min.	35	35	40	20	40
	HFE Max.	150	150	200	—	200
$I_c= 1.0 mA, V_{CE}=10v$	HFE Min.	75	75	100	80	100
	HFE Max.	225	250	300	—	300
Collector-Emitter Saturation Voltage, $V_{CE}(\text{sat})$						
$I_c= 150mA, I_B= 15mA$	$V_{CE}(\text{sat})$	0.4vdc	0.3vdc	0.3vdc†	0.4vdc	0.2vdc†
Base-Emitter Saturation Voltage, $V_{BE}(\text{sat})$						
$I_c= 150mA, I_B= 15mA$	$V_{BE}(\text{sat})$	1.3vdc	1.2vdc	0.85vdc	0.95vdc	.85vdc†

† $I_c=50mA, I_B=5mA$ on 2N3904

Rule of thumb for HFE:
 Conventions used in electronic literature:
HFE or **hFE** (upper case letters) is the **DC Current Gain**
Hfe or **hfe** (lower case) is the **AC current gain**

Fig. 1 – Constructing an HFE vs. I_c plot

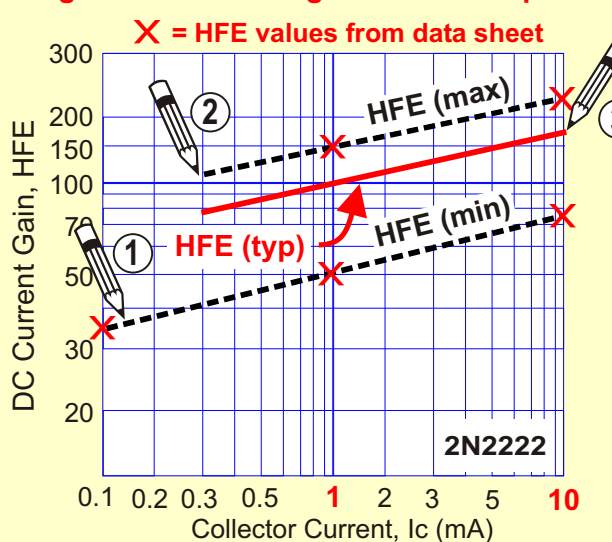

value, HFE typ., can then be drawn (line 3, Fig. 1). This gives you HFE (typ) for various collector currents.

The value used for HFE is not critical. Using HFE=100, or even the conservative value of 50, will work 99% of the time. Therefore, one scarcely needs the data sheets for the DC characteristics, as the typical HFE = 100 at Ic=1mA is valid for most general purpose NPN transistors. Fig. 2 shows Ib vs. Ic for HFE at 50 and 100.

Saturation voltages, VCE(sat) and VBE(sat), defines the transistor behavior *outside* the linear operating region, that is, in the saturated region. This is of interest when operating the transistor as a saturated switch. The keying transistor in a transmitter, forming the +12v transmit voltage on key-down, is an example of a saturated switch.

3. SMALL SIGNAL CHARACTERISTICS

The small-signal characteristics describe the AC performance of the device. There is no standardized industry definition of small-signal (vs. large-signal), but is generally defined where the AC signal is small compared to the DC bias voltage. That is, the signal levels are well within the linear operating region of the transistor.

The small signal characteristics include:

- 1) gain bandwidth product (**Ft**)
- 2) the AC current gain (**hfe**)
- 3) input and output impedances (**hie** and **hoe**)
- 4) input and output capacitances (**Cibo** and **Cobo**)
- 5) the noise figure (**NF**).

The small signal parameters are the most important to understand, as they describe the transistor's behavior at audio and RF frequencies, and used in the circuit design equations. These parameters vary greatly from one transistor type to another, such that making assumptions (as we did with DC HFE = ~100) can be risky. The data sheets must be used. The small-signal characteristics for **Ft** and **hfe**, from the data sheets, are shown in **Table 3**

Gain Bandwidth Product, or **Ft**, is defined as the frequency at which the AC current gain, hfe, equals 1 (0dB). See **Fig. 3** (next page). This is the maximum frequency the device produces gain as an amplifier or oscillator.

On RF transistor data sheets, Ft is not always given. Instead, the **power gain, Gp** (or **Gpe** for common emitter power gain) is tested at a specific frequency. Ft can be derived from this information as shown in **Table 4**. Equations *x* and *Gp(mag)* convert the power gain, in dB, to unitless magnitude, as is hfe.

Rule of thumb for HFE:
 Most general purpose NPN transistors have a DC HFE = 100 (typ) and thus used in most biasing equations for DC and low frequencies.

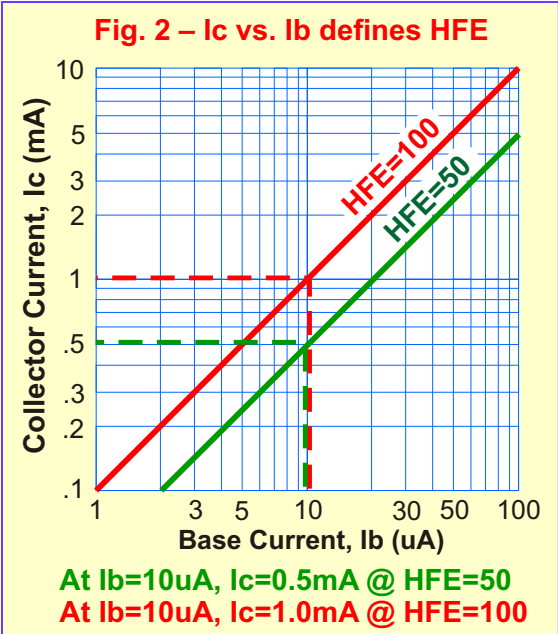

Table 3 – SMALL SIGNAL CHARACTERISTICS – Part 1

		2N 2222	2N 2222A	2N 3904	2N 4401	MMBT 3904
Gain Bandwidth Prod.	Ft (MHz).	250	300	300	250	300
Small Signal Current Gain, hfe						
Ic=1.0 mA, Vce=10v†	hfe Min.	50	50	100	40	100
	hfe Max.	300	300	400	500	400
	Estimated hfe Typ.	150	150	200	225	200
Ic= 10 mA, Vce=10v†	HFE Min.	75	75	—	—	—
	HFE Max.	375	375	—	—	—

† Measured at 1 KHz

Table 4 – Calculating Ft from Gpe

$$x = \frac{Gp(dB)}{10} \quad Gp(mag) = 10^x$$

$$Ft = f \sqrt{Gp(mag)}$$

Example:
 The data sheet for the 2N5179 lists Gpe=15dB at 200MHz. Determine Ft.

$$x = \frac{15dB}{10} = 1.5 \quad Gp(mag) = 10^{1.5} = 32$$

$$Ft = 200MHz \sqrt{32} = 1130 \text{ MHz}$$

hfe is the **ac small-signal current gain**, and dependent on both frequency and the collector current. Hfe is also known as the *ac beta*. Ft and hfe work together to define the overall AC gain of the transistor at a specific frequency, as illustrated in **Fig. 3**.

hfeo is the low-frequency hfe, often very close to the DC HFE. The values for hfe shown in the data sheets are normally measured at 1KHz and Ic=1mA (sometimes @10mA). Hfeo is fairly constant from the audio frequencies to about 300 KHz.

Beta cut-off frequency, f_f, is the "3db point" of hfe, where **hfe=0.707hfeo**, or **f_f=Ft/hfeo**. F_t is seldom listed on the data sheets.

hfe drops fairly linearly from f_f to Ft at 6dB/octave.

F_t, and the hfe vs. frequency plots, are seldom shown in the data books. **This is why learning to interpret the data sheets is important to determine the actual gain (hfe) a transistor will provide at a specific frequency.**

Design Example: Constructing an Hfe vs. Frequency Plot

Let's figure out what hfe will be for a 2N2222 on the 40M band, using both graphical and equational methods. It's really easy.

From **Table 3**, hfe=50 (min) to 300 (max). Let's pick hfe=150 as the average. Since hfe is measured at 1KHz, this is also **hfeo**. Draw a line on a chart to represent hfeo=150 (line #1, **Fig. 4**).

Calculate f_f and hfe @f_f as follows: (Ft=250MHz, 2N2222)

$$f_f = Ft/hfeo = 250MHz / 150 = 1.7 MHz$$

$$hfe@f_f = .707hfeo = 0.707 \times 150 = 106$$

Draw a dot at hfe@f_f on the chart (hfe=106 @ 1.7 MHz)

Or ... calculate hfe at the desired frequency, fo, such as 7MHz

$$hfe@fo = Ft/fo = 250MHz / 7MHz = 36$$

Draw a line between f_f (or fo) and Ft (line #2, **Fig. 4**) to complete the hfe vs. frequency plot of the 2N2222 at Ic=1mA.

Therefore, at 7 MHz

$$ac\ gain\ is\ hfe = 36$$

How much signal gain will the 2N2222 provide at 144 MHz?

$$hfe = Ft/fo = 250MHz / 144MHz = 1.7, or\ almost\ unity!$$

This is why general purpose transistors (Ft <400MHz) are not used at VHF for lack of useful gain above ~50 MHz.

Hfe vs. Ic. Hfe is also a function of Ic as shown in **Fig. 5**. This data sheet chart is used to adjust hfe at Ic other than 1mA, where hfe is measured. For designing battery powered circuits, Ic=1mA is recommended. Firstly, data sheet values can be used directly, saving additional calculations, since most parameters are listed for Ic=1mA. Secondly, these transistors have ample gains at Ic=1mA or less. The additional gain at a higher Ic may not justify

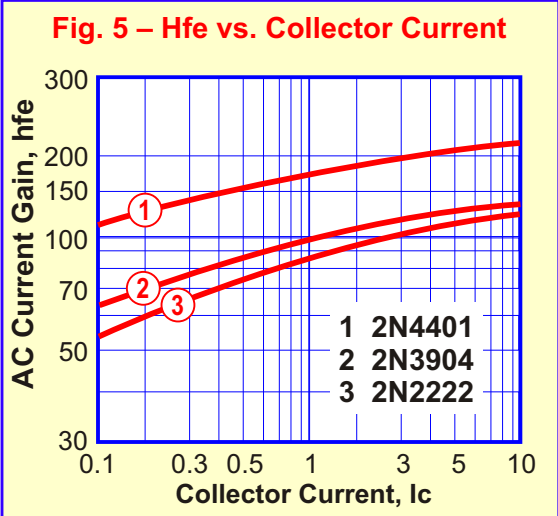
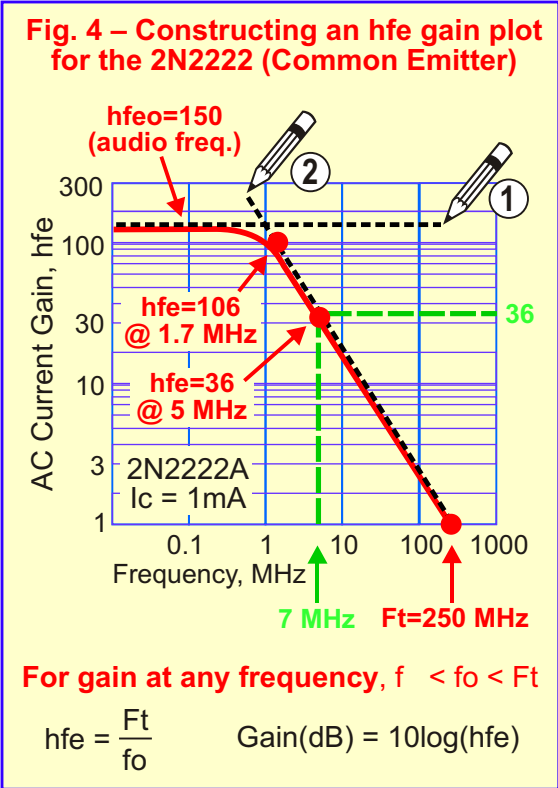
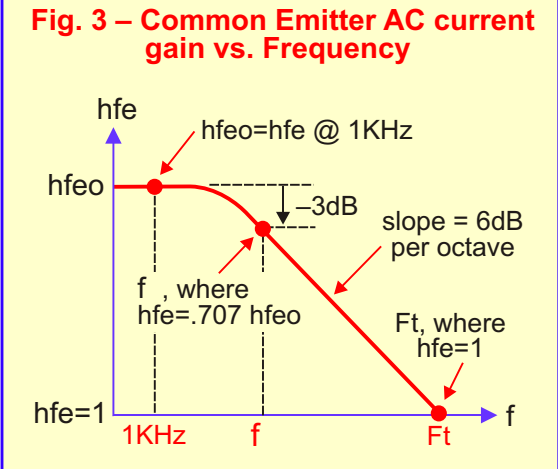

the increase in battery drain. I.e., two amplifiers at $I_c=1\text{mA}$ will yield far more gain than one amplifier at $I_c=2\text{mA}$.

Table 6 shows h_{fe} at different frequencies for the 2N2222.

Table 5 lists the remaining small-signal characteristics.

Input impedance, h_{ie} , is the resistive element of the base-emitter junction, and varies with I_c . It is used for input impedance calculations, and not particularly useful in itself without considering C_{ibo} .

Input capacitance, C_{ibo} , is the capacitance across the base-emitter junction. For the 2N2222, $C_{ibo}(\text{max})=30\text{pF}$. The reactance (X_c) of C_{ibo} is in parallel with h_{ie} ($X_c||h_{ie}$) – causing the equivalent input impedance, Z_{in} , to be frequency dependent as shown in **Table 6**. As can be seen, $X_c(C_{ibo})$ dictates the input impedance of the transistor, *not h_{ie}* . C_{ibo} is thus important in estimating Z_{in} at any given frequency. In selecting a transistor for RF, the smaller the value of C_{ibo} , the better. In this case, the input *impedance* is called Z_{in} , since it includes the frequency dependent *reactance* components.

Input resistance, R_{in} , for the common-emitter transistor, can also be estimated using h_{fe} and emitter current, I_e , as follows:

$$R_{in} = r_e(h_{fe}+1) \quad \text{where, } r_e = 26 \text{ } I_e(\text{mA}) \text{ (} I_e \text{ } I_c \text{)}$$

The results of R_{in} from the above are also shown in **Table 6** for comparison. This method is generally preferred since h_{fe} and I_e are known with greater accuracy than is h_{ie} and C_{ibo} . In this case, the input *impedance* is called R_{in} , since it only includes resistive components (no *reactance* components).

The differences between the two methods, while close, demonstrates the difficulty in determining with certainty the input impedance of a transistor.

Output Admittance, h_{oe} , represents the output resistance of the transistor by taking the reciprocal of the admittance. For example, at $h_{oe}(\text{typ})=10\mu\text{mhos}$, $R_{out} = 1/h_{oe} = 1/10\mu\text{mhos} = 100\text{K}$. Like h_{ie} , h_{oe} is not particularly useful by itself.

Output Resistance, R_o , is approximately the parallel equivalent of h_{oe} and the collector load resistance, R_c , or $R_o = R_c||h_{oe}$. See **Fig. 6**. Since R_c tends to be in the 1–5K range, and h_{oe} 20–100K, R_c will dominate the output resistance of the transistor. As a result, output impedance is usually estimated by: $Z_o \approx R_c$. Note that the output impedance is set primarily by circuit values (R_c), and not by the transistor's small-signal parameters.

Table 5 – SMALL SIGNAL CHARACTERISTICS – Part 2

		2N 2222	2N 2222A	2N 3904	2N 4401	MMBT 3904
Input capacitance ‡	C_{ibo} (max)	30pF	25pF	8pF	30pF	8pF
Output capacitance ‡	C_{obo} (max)	8pF	8pF	4pF	7pF	4pF
Input Impedance, typ. †	h_{ie} (min)	2K	2K	1K	1K	1K
	h_{ie} (max)	8K	8K	10K	15K	10K
Output Admittance †	h_{oe} (min)	5*	5*	1*	1*	1*
	h_{oe} (max)	35*	35*	40*	30*	40*
Noise Figure †	NF (max)	4dB	4dB	5dB	4.5dB	4dB

† Measured at 1 KHz ‡ Measured at 1 MHz * mhos

Table 6 – 2N2222 Input Impedances

Freq	based on $h_{fe}=150$	based on h_{fe} and r_e	based on $X_c(C_{ibo}) h_{ie}$	
	h_{fe}	R_{in}	$X_c(C_{ibo})$	Z_{in}
3.5	71	1872	1516	1150
7.0	36	962	758	658
10.1	25	676	525	475
14.0	18	494	379	352
21.0	12	312	253	241
28.0	9	234	190	183
50.0	5	130	106	104
144	2	52	37	36

$$R_{in} = r_e(h_{fe}+1) \text{ where, } r_e = 26 / I_e(\text{mA}) = 26 \text{ @ } 1\text{mA}$$

$$Z_{in}(\text{eq}) = X_c || h_{ie} \text{ where, } C_{ibo} = 30\text{pF}, h_{ie} = 5\text{K}$$

Fig. 6 – Input/Output Impedances basic amplifier configuration

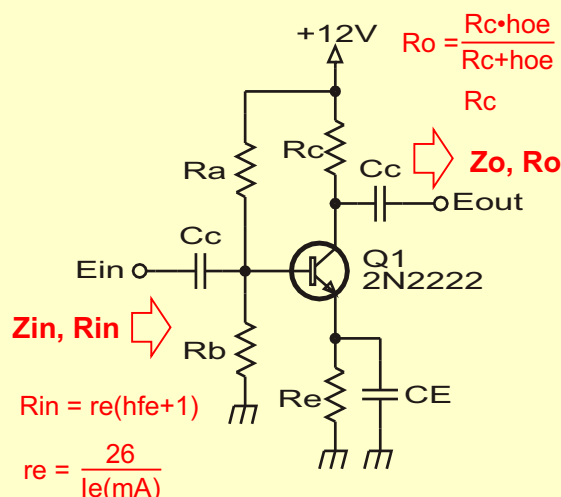

Cobo is the **output capacitance**, and is in parallel with the output resistance. However, Cobo is <10pF in most general purpose NPN transistors and has little effect at HF. This parameter is important in RF transistors operating in the VHF/UHF spectrum, where the shunting effect becomes a significant component of the output impedance. Obviously, the lower the value of Cobo, the better.

Noise Figure, NF, is defined as the ratio of the input to the output noise, neither of which is easily measurable by the amateur. The transistor will add noise, then be amplified by the hfe of the device just as the signal is, forming signal plus noise output, or S+N. The excess in the S+N to signal power is due to the noise figure (NF) of the device.

For the QRPer, the NF of the transistor is not highly important on HF. See **Table 7**. Select a transistor with a low NF for the audio stage(s), however, as this is where it will be the most evident.

Transconductance, gm, is another parameter provided on some data sheets. If not provided, gm can be estimated by:
 $gm = .038 \times I_e(\text{mA})$.

Table 7 – HF vs VHF Noise Figures

At HF – antenna and atmospheric noise is in the 20–30dB range, far exceeding the 10-12dB NF of a typical HF receiver. In other words, more noise is introduced to the receiver by the antenna and band conditions than the NF of the stages can introduce. For HF receiver applications, a NF of 4-6dB per transistor is sufficient. This is not the case at VHF.

At VHF/UHF – antenna and atmospheric noise is very low, often less than 10dB of noise power, making the overall system noise a function of the receiver, and the NF of the individual stages. At VHF/UHF, the NF of the transistors becomes very important, with transistors being selected with NF's in the 1.5dB to 2dB range not uncommon.

4. SWITCHING CHARACTERISTICS

The Switching Characteristics define the operating limits of the transistor when used in pulsed, digital logic, or switching applications. QRP switching circuits include T-R switching, CW keying and band switching circuits using transistors. These are really large-signal characteristics, since the transistor is being driven from cut-off to saturation in most switching applications.

Table 8 – SWITCHING CHARACTERISTICS

		2N 2222	2N 2222A	2N 3904	2N 4401	MMBT 3904
Delay time	td	10ns	10ns	35ns	15ns	35ns
Rise time	tr	25ns	25ns	35ns	20ns	35ns
Storage time	ts	225ns	225ns	200ns	225ns	200ns
Fall time	tf	60ns	60ns	50ns	30ns	50ns

Fig. 7 illustrates the switching characteristics terms: **td, delay time** is the time from the input L–H transition until the output begins to respond.

tr, rise time is the time it takes the output to go from 10% to 90% output voltage.

ts, storage time is the time from the input H–L transition until the output responds. This is usually the longest delay.

tf, fall time is the time it takes the output to go from 90% to 10% output voltage.

These switching times, in the tens of nanoseconds, are thousands of times faster than the requirements for QRP applications, and seldom a design criteria when selecting a transistor. It is presented here for completeness only.

Fig. 7 – Switching Characteristics

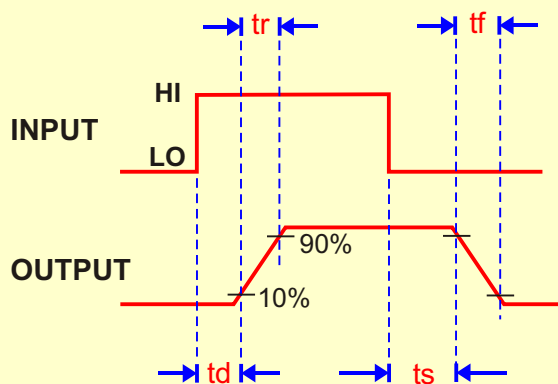

This tutorial should allow one to interpret the transistor data sheets, whether the complete data sheets from the manufacturer, or the abbreviated listings, such as found in the NTE Cross-Reference or in the ARRL Handbook. Many manufacturer's provide complete data sheets online. Understanding transistor specifications is essential in designing your own circuits, or identifying those "ham fest special" transistors and their suitability for your next project. Biasing transistors using these specs will be presented in a future *Handyman's* tutorial.